

CONDUIT LAYOUT

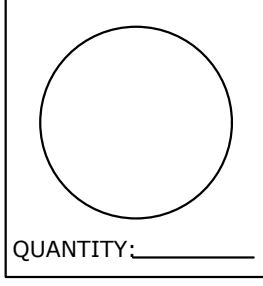

BOLT PATTERN: _____
 CONDUIT SIZE: _____
 ABOVE GRADE: _____

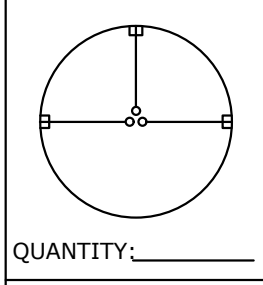
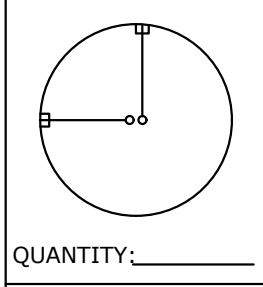
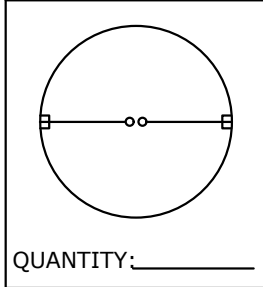
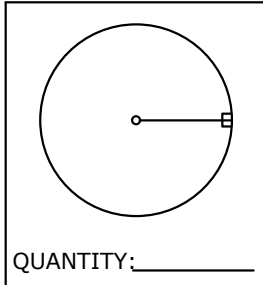
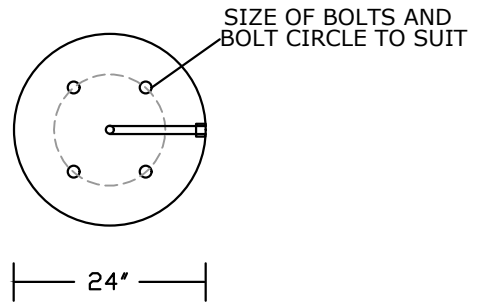

PLAN VIEW

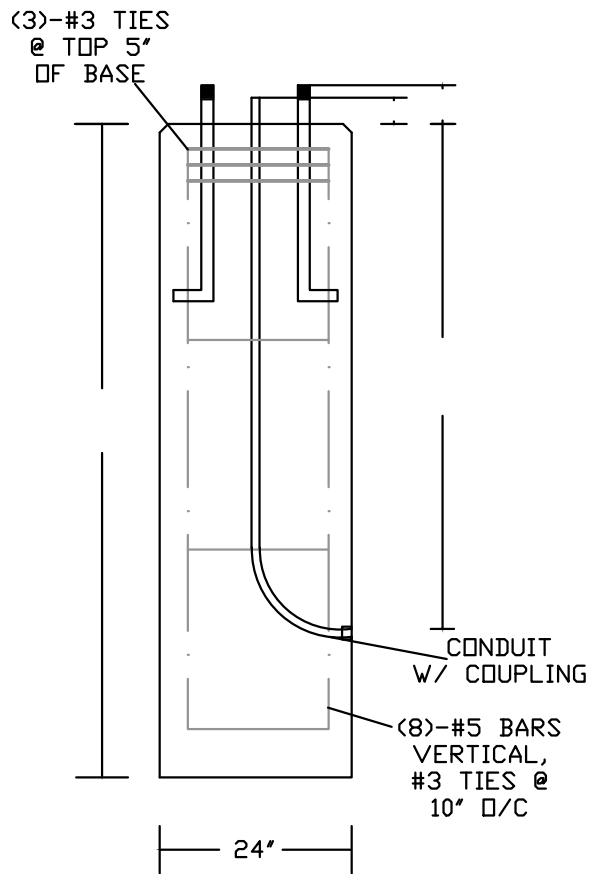

SECTION VIEW

NOTES:

- CONCRETE 5,000 PSI @ 28 DAYS
- WEIGHT PER V.F. 24"- 490 LBS.
- ALL RAW/UNGLUED MATERIAL (CONDUIT, ELBOWS, COUPLINGS, AND ANCHOR BOLTS W/ 2 NUTS) TO BE PROVIDED BY CONTRACTOR BEFORE PRODUCTION
- WEIGHT: _____ LBS.
- TOTAL NUMBER OF BASES: _____

PEERLESS CONCRETE PRODUCTS CO.

246 Main Street
 Butler, NJ 07405
 973.838.3060p

SINCE 1959

sales@peerlessconcrete.com

www.peerlessconcrete.com

24" DIA. LIGHT POLE BASE

CUSTOMER:

PROJECT:

SCALE: N.T.S.

DATE: 2/2026

EST#:

I-4